

# FourCast®2 Wheeler

EN

Design: Strand + Hvas

## Shell colour

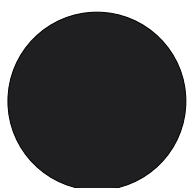

EBONY BLACK

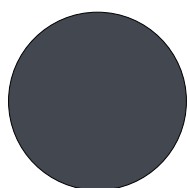

ANTHRACITE

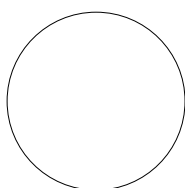

SNOW

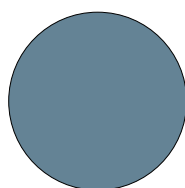

AQUA

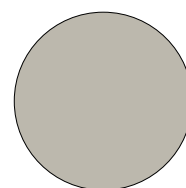

BEACH

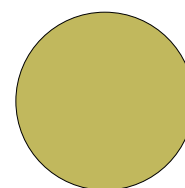

OLIVE

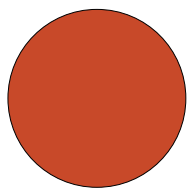

ORANGE

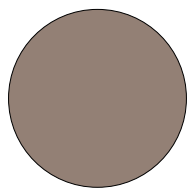

TERRACOTTA

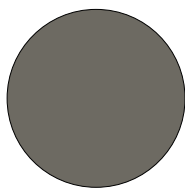

CLAY



OAK VENEER

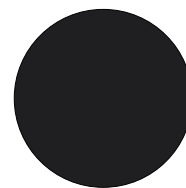

BLACK STAINED  
OAK

## Frame colour

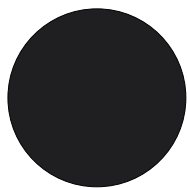

MAT BLACK

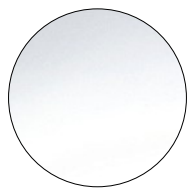

POLISHED ALUMIN-  
IUM

## Options

Upholstery: Seat upholstery / Fully upholstered

Inno®Tab

Extra high gas lift

Free Float

Gas lift incl. foot ring

Aluminium base

Hook

## Note

GS version:

Castors with brake (unloaded), big crossing, lower gas cylinder.

# FourCast<sup>®</sup>2 Wheeler

EN

Design: Strand + Hvas

## 1 FourCast2 Wheeler

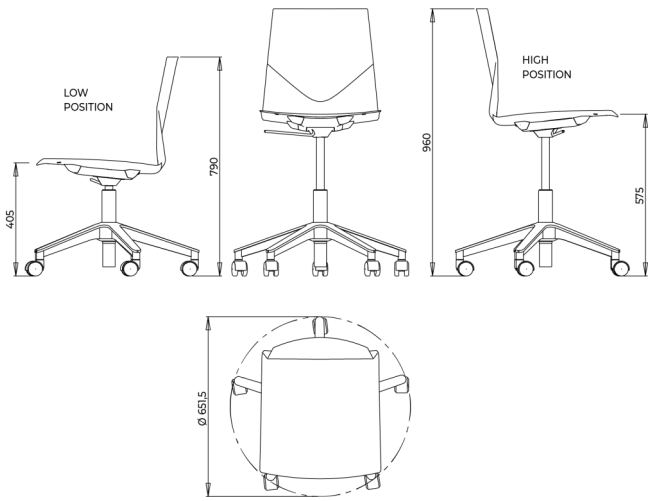

## 2 FourCast2 Wheeler Loop Armrest

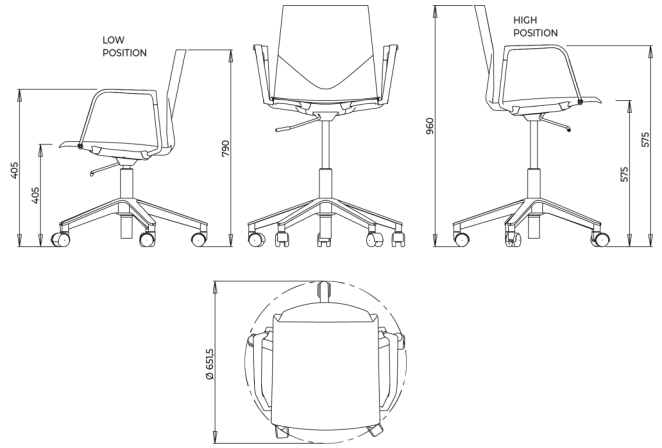

# FourCast® 2 Wheeler

EN

Design: Strand + Hvass

## Materials

### Shell

PP, reinforced glass fibre (15%), recyclable. Recyclable. Meets the RoHS and REACH directives and are halogen free.

Foam: Type CMHR-65H eco-tex standard 100 and The Furniture and Furnishings (Fire) (Safety) Amended Regulations 1989 Schedule 1, Part 1.

Upholstered shell: 9-11 layer veneer beechwood (12 mm).

Glue veneer: Casco Adhesive 1272.

Glue Foam: SABA Activator 3739, Aquabond RSD 3801 blue.

Foam thickness: Seat upholstery: 15 mm.

Fully upholstered: 25 mm. (seat) - 10 mm. (back).

### Frame, Steel

Gas lift: St. 37

Lock: ABS/Pa6

Upholstery protector: ABS

Castors: Pa6

## Weight and dimensions

Weight: 7,4 kg

Dimensions are valid for chairs in polypropylene and without upholstery.

## Quality and environment

At Four Design, we are aware of our environmental responsibility.

We strive to reduce our company, and our customer's impact on the environment by producing quality furniture in a sustainable manner.

### Procurement

We procure materials from responsible suppliers who comply with our high standards, ensuring that the materials are sustainably sourced and managed, conforming to applicable laws and regulations such as legal logging and chemical restrictions.

### Production

We are ISO14001 certified, guaranteeing excellent environmental standards of our manufacturing sites.

### Use

Four Design provides a 5-year warranty on all products within our price list. This warranty covers breakage and damage of products occurring because of deficient craftsmanship performance under normal use. The warranty shall lapse if the product shows signs of mishandling abuse or other physical damage. The warranty does not cover those parts of the product which are exposed to abrasion during use.

We kindly refer to our Maintenance Guide: [http://www.fourdesign.dk/pdf/Maintenance\\_Guide.pdf](http://www.fourdesign.dk/pdf/Maintenance_Guide.pdf)

### Recycling

We are working towards the aim for all our products to be minimum 95% recyclable.

Products must be separated into their components and disposed of separately.

All metal parts can be disposed of and recycled by an approved organisation. Lacquered frames are treated with a paint classified as not dangerous according to directive 1999/45/EF.

Wood can either be recycled or incinerated.

Plastic shells can be recycled. The shell will be granulated and reused in new plastic production.

Upholstery and veneer shells are not recyclable but can be disposed of by incineration.