

Design: Studio Ocee

Table top finishes

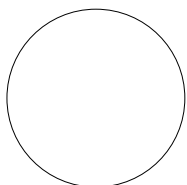

WHITE DECOR
W450

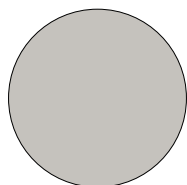

LIGHT GREY EGGER
U763 ST9 DECOR

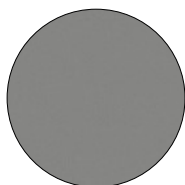

GREY EGGER U732
ST9 DECOR



ANTHRACITE ARPA
FENIX 0724



BLACK ARPA FENIX
0720

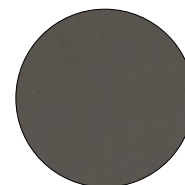

WARM GREY ARPA
FENIX 0718

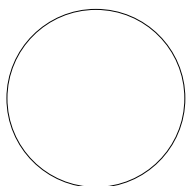

WHITE MDI38
MODEKOR

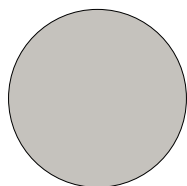

LIGHT GREY EGGER
U763 ST9 LAMINATE

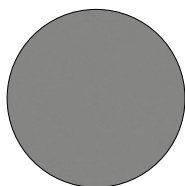

GREY EGGER U732
ST9 LAMINATE

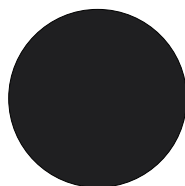

LINOLEUM BLACK

Frame colours

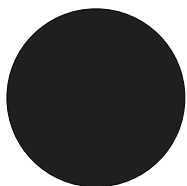

MAT BLACK

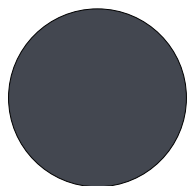

MAT GREY

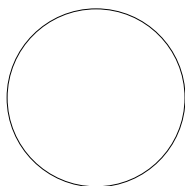

MAT WHITE

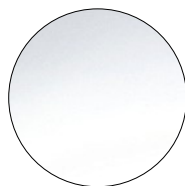

CHROME

Options

Chair suspension, flower boxes, top plate

FourReal® A

EN

Design: Studio Ocee

FourReal A 74 - L1400 W800

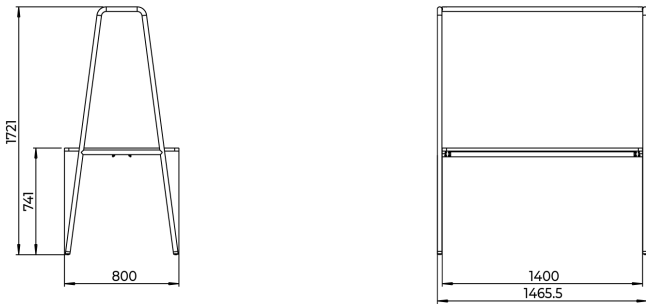

FourReal A 74 - L1800 W800

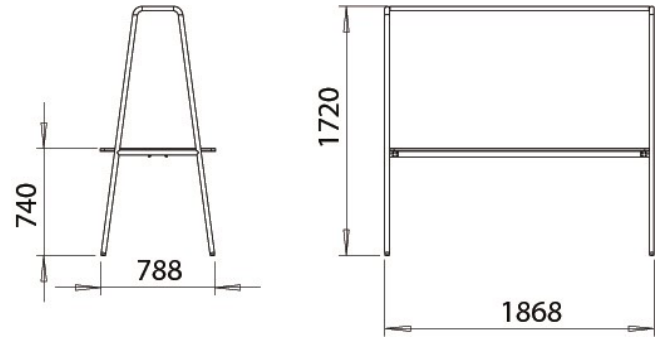

FourReal A 90 - L1400 W800

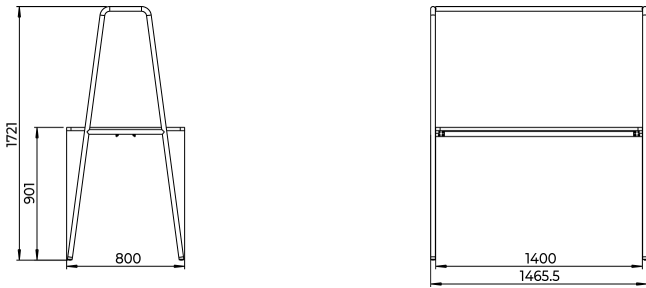

FourReal A 90 - L1800 W800

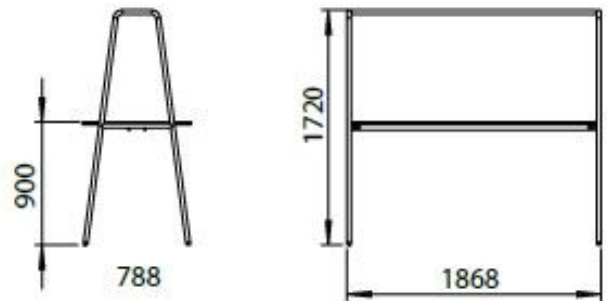

Design: Studio Ocee

Materials

Table top variants

Chip board with Decor laminate and ABS-edge.
Thickness: 19 mm.

Chip board with high-pressure laminate or Fenix laminate and ABS edge. Thickness 19 mm.

MDF board with linoleum and linoleum edges.
Thickness 22 mm.

Frame

Legs: $\varnothing 32$ x 2.5 mm, S235 steel, EN 10305-3 F300C

Rail: Aluminium EN AW-6063 T.

Gliders with integrated castors: LDPE

Gliders: LDPE

Fasteners

M6x16 Countersunk

M6 Self locking Nut

Instructions

Assembly instruction can be found at www.fourdesign.dk under FourReal A.

Weight and dimensions

H 74:

140x80 cm: 25,4 kg

180x80 cm: 30,1 kg

H 90:

140x80 cm: 25,1 kg

180x800 cm: 29,9 kg

table top and frame supplied separately!

Quality and Environment

At Four Design, we are aware of our environmental responsibility.

We strive to reduce our company, and our customer's impact on the environment by producing quality furniture in a sustainable manner.

Procurement

We procure materials from responsible suppliers who comply with our high standards, ensuring that the materials are sustainably sourced and managed, conforming to applicable laws and regulations such as legal logging and chemical restrictions.

Production

We are ISO14001 certified, guaranteeing excellent environmental standards of our manufacturing sites.

Use

Four Design provides a 5-year warranty on all products within our price list. This warranty covers breakage and damage of products occurring because of deficient craftsmanship performance under normal use. The warranty shall lapse if the product shows signs of mishandling abuse or other physical damage. The warranty does not cover those parts of the product which are exposed to abrasion during use.

We kindly refer to our Maintenance Guide: http://www.fourdesign.dk/pdf/Maintenance_Guide.pdf

Recycling

We are working towards the aim for all our products to be minimum 95% recyclable.

Products must be separated into their components and disposed of separately.

All metal parts can be disposed of and recycled by an approved organisation. Lacquered frames are treated with a paint classified as not dangerous according to directive 1999/45/EF.

Wood can either be recycled or incinerated.

Plastic shells can be recycled. The shell will be granulated and reused in new plastic production.

Upholstery and veneer shells are not recyclable but can be disposed of by incineration.